

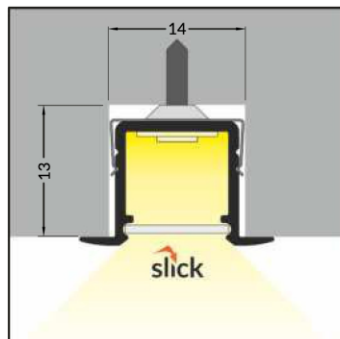

# LED-Einbauprofil Jupiter (18,8x12 mm)

**A** Abdeckung **A** einschiebbar

**Z**<sup>1</sup> Halter **Z** flexibel

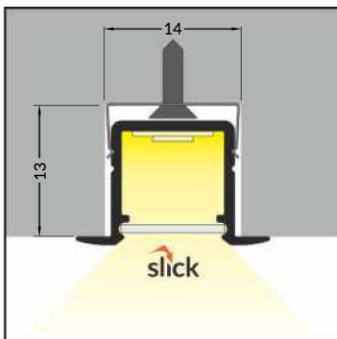
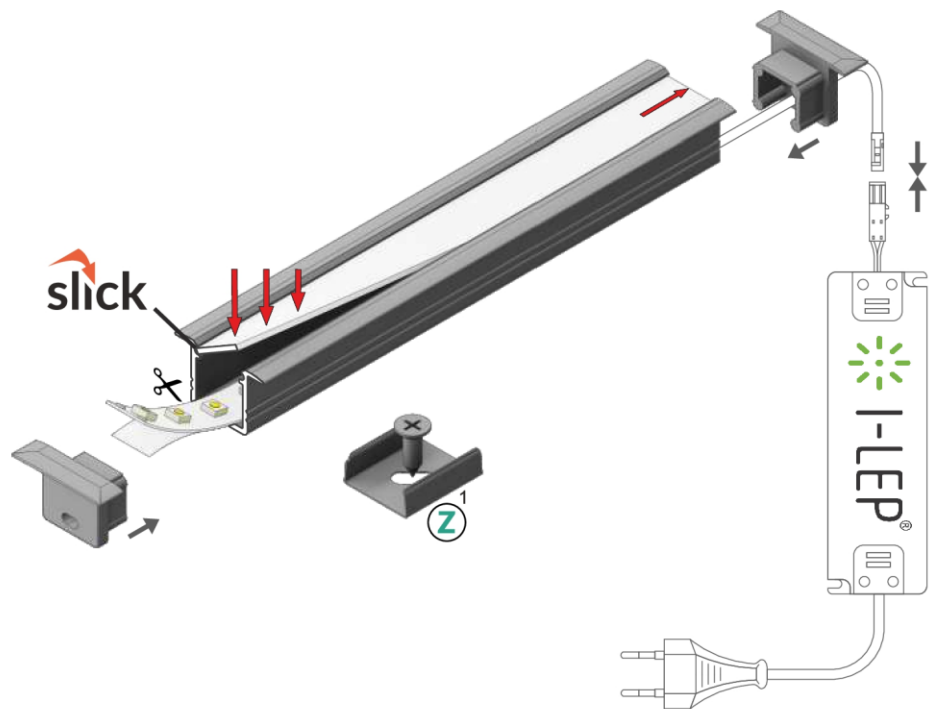

 weiß lackiert  
07-323100-1812



 eloxiert  
07-322100-1812



 schwarz eloxiert  
07-324100-1812

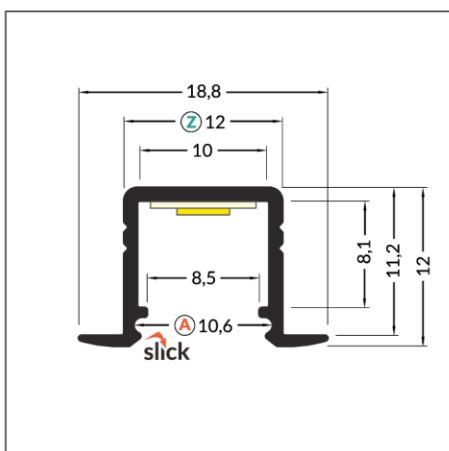

 max 10 mm

# ZUBEHÖR

## ABDECKUNG

Abdeckung **A** einschiebbar  
 Farben: transparent, satiniert, opal  
 Material: PC, PP, PP

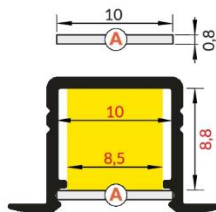

**A** transparent  
 07-300013-1008

**A** satiniert  
 07-300012-1008

**A** opal  
 07-300011-1008

## ENDKAPPEN

Endkappe mit Öffnung  
 Farben: weiß, silbern, schwarz, grau  
 Material: ABS

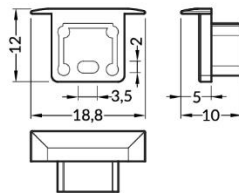

○ weiß  
 07-320301-1812

● silbern  
 07-320306-1812

● schwarz  
 07-320304-1812

## HALTER

Halter **Z** flexibel  
 Farben: weiß, inox, schwarz  
 Material: rostfreier Stahl

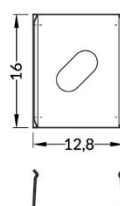
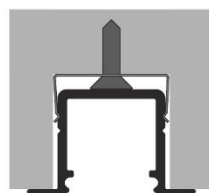

Halter **Z** flexibel

○ weiß  
 07-300481-1216

● inox  
 07-300488-1216

● schwarz  
 07-300484-1216

